

## NPC SERIES - NPC38-12I

The low maintenance and valve regulated constructions combine with heavy-duty plates and unique separator systems to make NPC service twice as long as conventional counterparts.

### FEATURES

#### 1. Double cycle life

NPC operates 500 charge/discharge cycles or twice as many cycles as conventional cycle use batteries at 75%D.O.D. (depth of discharge).

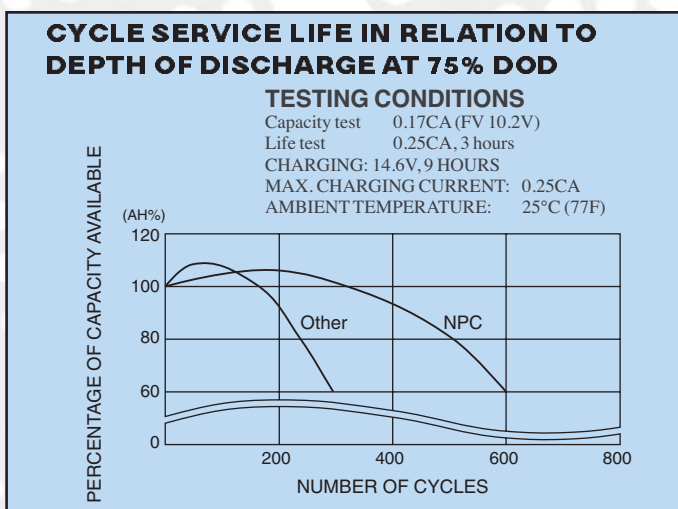

#### 2. Valve-regulated and maintenance-free

Battery electrolyte retained solidly in the separator and the innovative gas recombinant system allows minimum gas emittance freeing the user from maintenance.

#### 3. Durability for deep discharge use

Yuasa's state-of-the-art plate barrier prevention and the unique separator systems help endure deep discharge use thus considerably prolonging battery's service life.

#### 4. Minimal self-discharge

Cyclic use batteries tend to be left discharged after usage causing plate corrosion leading to shortened life. Self discharge rate of NPC is as small as only 0.1% a day at 20°C and thus extends the storage period allowed.

### Operating temperature range

Charge: -15 ~ 50°C (5 ~ 122°F)  
 Discharge: -15 ~ 50°C (5 ~ 122°F)  
 Storage: -20 ~ 50°C (-4 ~ 122°F)

### Specifications

NPC Model	Volts	Rated Capacity (20 hr rate) (Ah)	Approx. Dimensions			Weight	Layout	Terminals
			Length	Width	Overall height incl. terminals			
NPC38 - 12I	12	38	197mm	165mm	170mm	14kg	2	J



### Recommended charging method

Current: Max. 0.25CA Voltage: 2.4 ~ 2.5VPC

### Applications

- Wheelchairs • Golf trolley • Lawn mowers • Lights
- Toy cars • Sprayers • Photovoltaics • Robots
- Communications • Electric tools • Pumps
- Measuring instruments • AGV (Automatic guided vehicle)
- Magnetic lifts

### Terminals

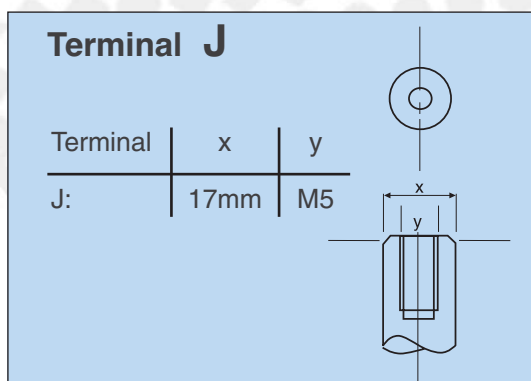

### Layout

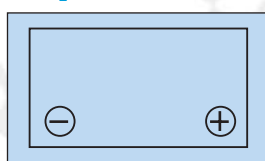

### CAUTION

- Avoid short circuit.
- Do not charge in a sealed container.
- Service life and operational characteristics will be affected by temperature.
- AC Ripple reduces service life.

## Performance

### CYCLE SERVICE LIFE IN RELATION TO DEPTH OF DISCHARGE

#### TESTING CONDITIONS

Capacity test 0.17CA (FV 10.2V)  
 Life test 0.25CA, 3 hours  
 CHARGING: 14.6V, 9 HOURS  
 MAX. CHARGING CURRENT: 0.25CA  
 AMBIENT TEMPERATURE: 25°C (77°F)

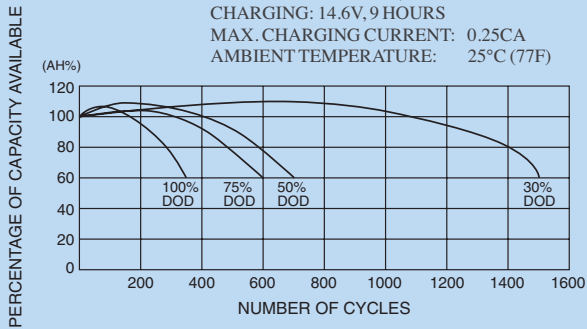

### CONSTANT CURRENT, CONSTANT VOLTAGE CHARGING CHARACTERISTICS

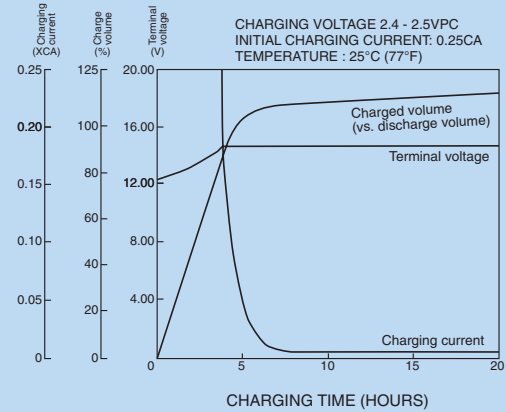

### DISCHARGE CURRENT VS. DURATION TIME

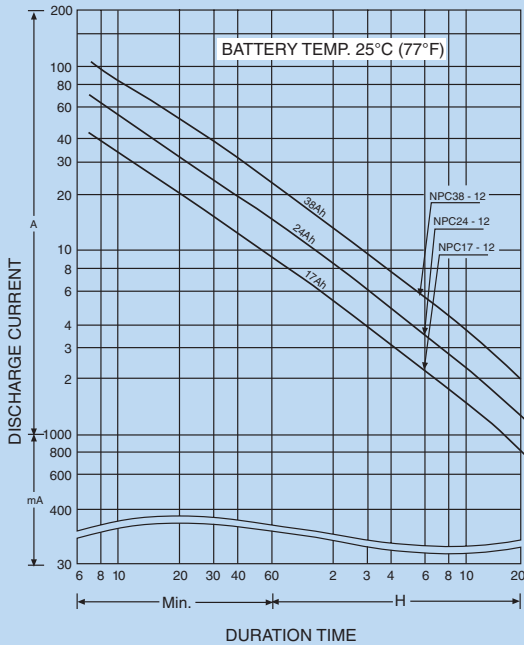

### DISCHARGE CHARACTERISTICS AT VARIOUS CURRENTS (25°C (77°F))

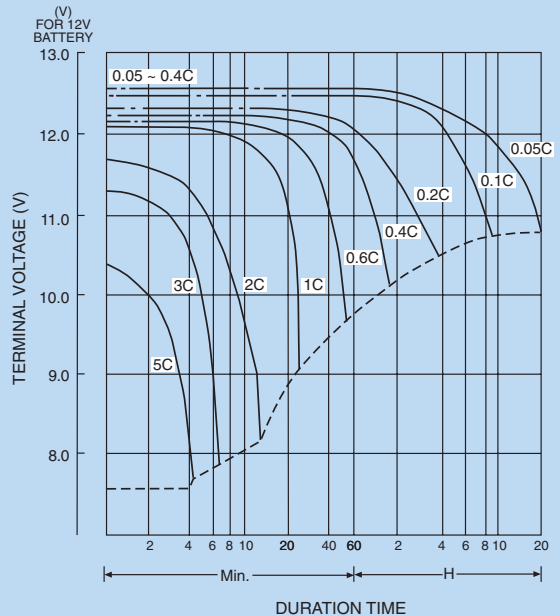

### SELF DISCHARGE CHARACTERISTICS

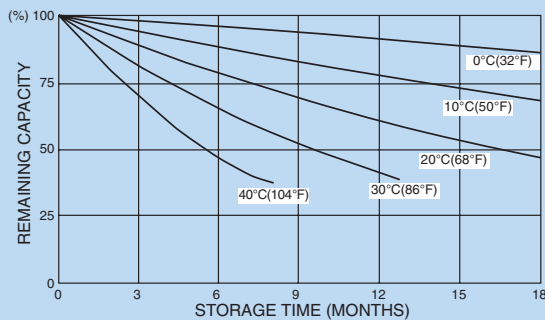

### CYCLIC RECHARGE REGIME

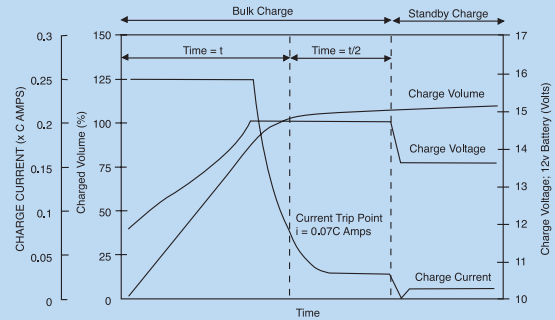

### Yuasa Battery Sales (UK) Ltd

Unit 22 Rassau Industrial Estate  
 Ebbw Vale, Gwent, NP23 5SD  
 Tel: 08708 500312 Fax: 08708 500317  
 E-mail: enquiries@yuasa-sales.co.uk

Registered number 1548820

Cat. No. NPC38-12I February 07

E&O.E.

Distributed by